

# Rotary vane pump RZ 9

[Link to the website](#)

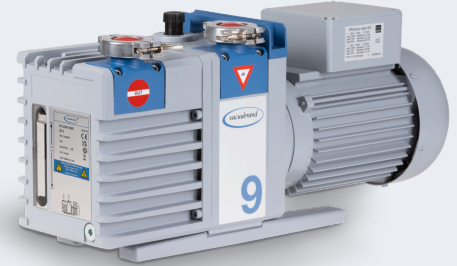

## Product description

The RZ 9 is a two-stage powerful rotary vane pump for fast evacuation of vessels and at higher gas flow rates.

## Performance features

- very high flow rates even at vacuum levels approaching ultimate vacuum
- high water vapor tolerance due to efficient gas ballast; very good ultimate vacuum even with gas ballast
- vacuum-tight at switch-off; external anti-suckback valve not needed
- large oil volume: Long intervals between oil changes
- ease of maintenance due to telescopic design

## Ordering data

Product name	Nominal mains voltage   mains frequency	Plug type	Articleno.
RZ 9	230 V   50-60 Hz	CEE	20798140
RZ 9	230 V   50-60 Hz	CH, CN	20798141
RZ 9	230 V   50-60 Hz	UK, IN	20798142

## Items supplied

Pump oil filled and completely mounted, ready for use, with manual.

## Accessories

- Oil mist filter outlet side FO R 8/9/16 (20698017)
- Butterfly valve VS 25 (20665005)
- Clamping ring for small flange KF DN 20/25 (20660001)
- External centring ring for small flange KF DN 20/25 (20660196)
- Small flange with hose nozzle KF DN 25 / DN 10 mm (20662807)
- Metal vacuum tubing with small flanges KF DN 25 (20673337)
- Rubber vacuum tubing DN 10 mm (20686002)
- Maintenance kit RE 8 - RZ 16 (20649988)

## Technical data

Max. pumping speed 50 Hz (m <sup>3</sup> /h)	8.9 m <sup>3</sup> /h
Max. pumping speed 60 Hz (cfm)	6.0 cfm
Ultimate vacuum	2 x 10 <sup>-3</sup> mbar / 1.5 x 10 <sup>-3</sup> torr
Ultimate vacuum with gas ballast	1 x 10 <sup>-2</sup> mbar / 0.75 x 10 <sup>-2</sup> torr
Ultimate partial vacuum without gas ballast	4 x 10 <sup>-4</sup> mbar / 3 x 10 <sup>-4</sup> torr
Water vapor tolerance	40 mbar / 30 torr
Number of stages	2
Permissible ambient temperature range (operation)	15 - 40 °C
Permissible ambient temperature range (storage)	-10 - 60 °C
Max. outlet pressure (abs.)	1.1 bar
Oil capacity min./max.	0.45 / 0.85 l
Inlet connection	small flange KF DN 25
Outlet connection	small flange KF DN 25
Rated motor power	0.30 kW
Rated speed 50/60 Hz	1500/1800 min <sup>-1</sup>
Protection class IEC 60529	IP 40
Dimensions (L x W x H)	503 mm x 156 mm x 240 mm
Weight	24.8 kg
Noise (sound pressure level) in dBA at 50 Hz or 1500 rpm/62% (VARIO)/1500 rpm (VARIO-SP)/12500 Upm (VACUU-PURE®)	52 dBA
NRTL certification	No

Pumping speed graph at 50 Hz

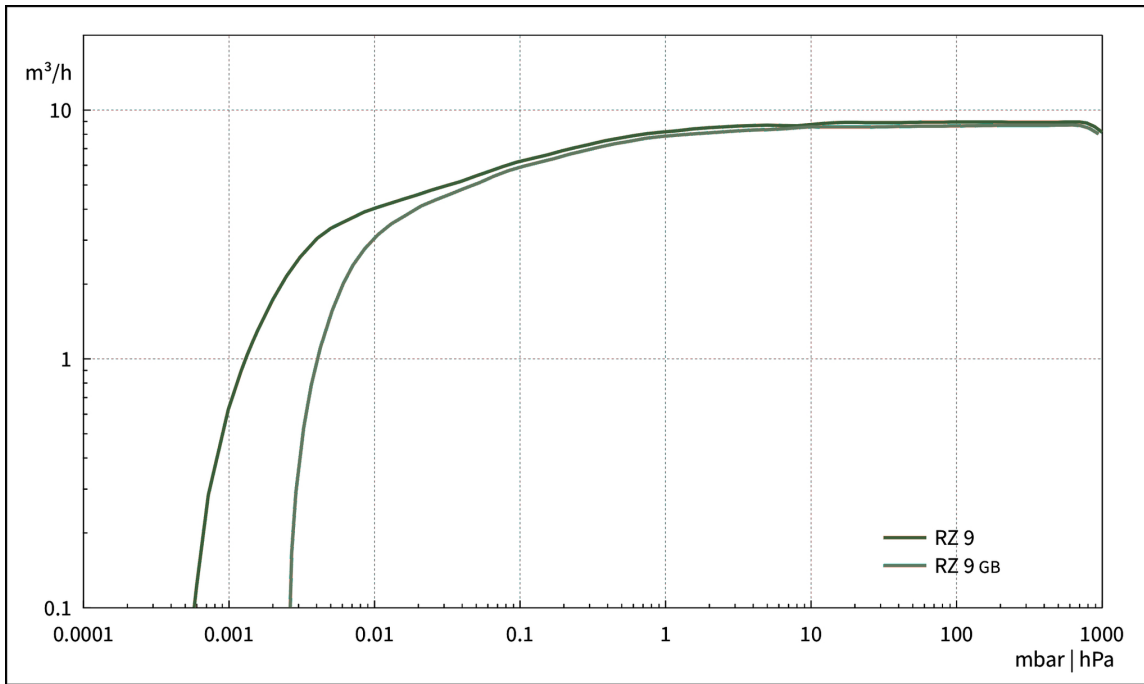

Pump down graph at 50 Hz (100 l volume)

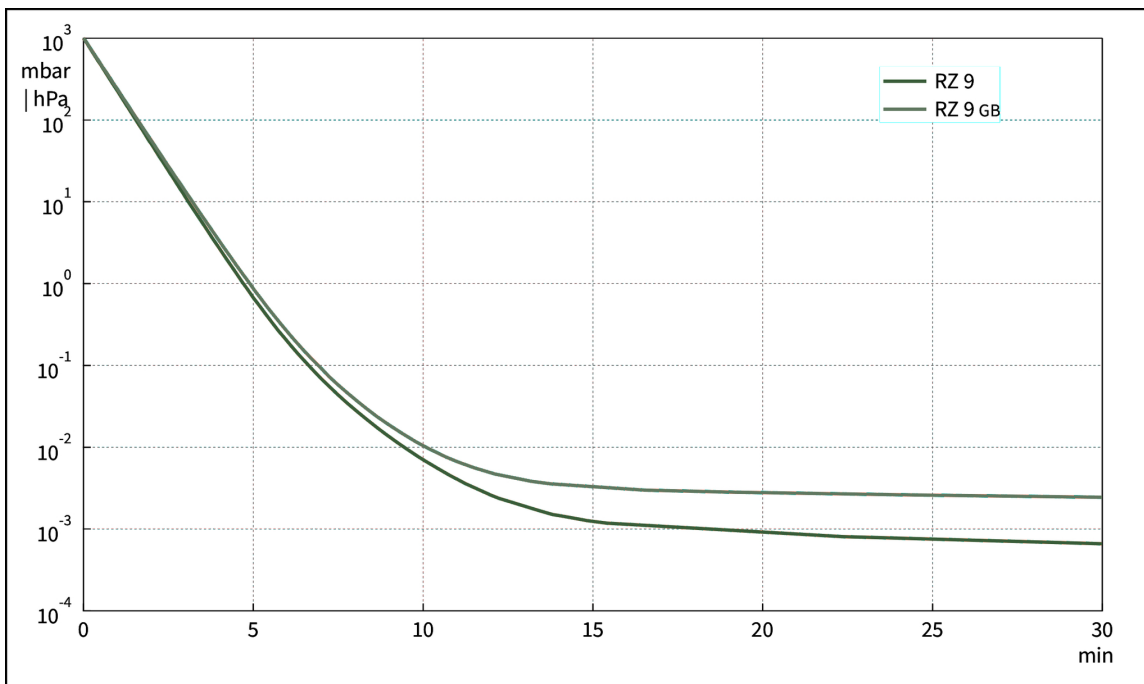

Pumping speed graph at 60 Hz

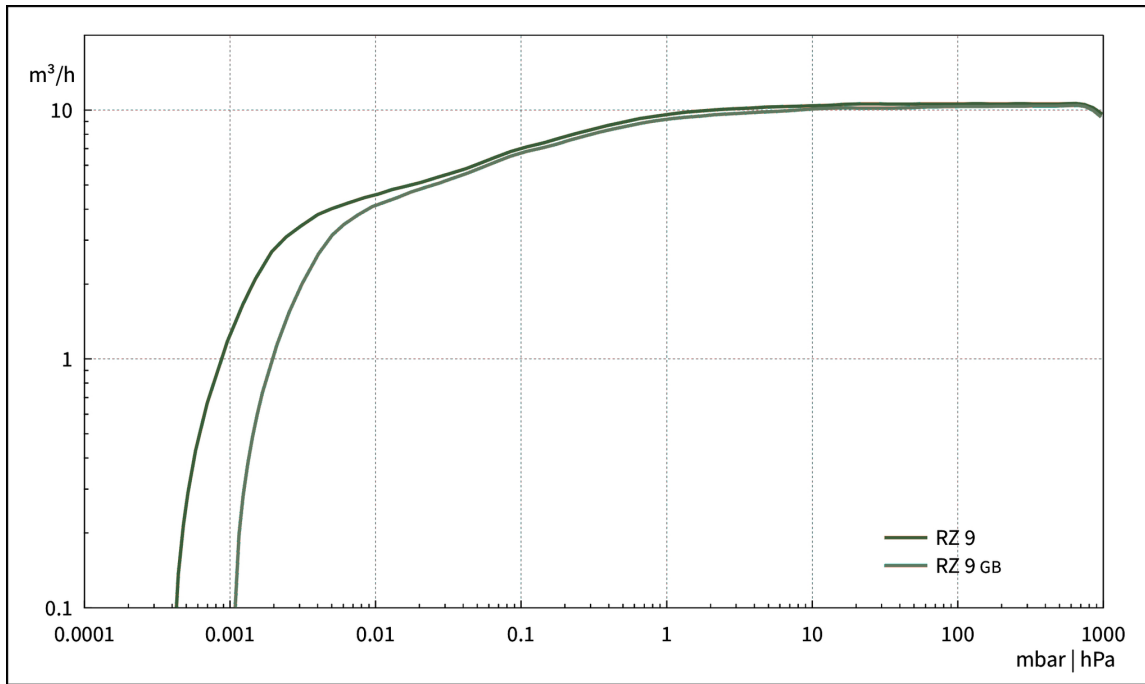

Pump down graph at 60 Hz (100 l volume)

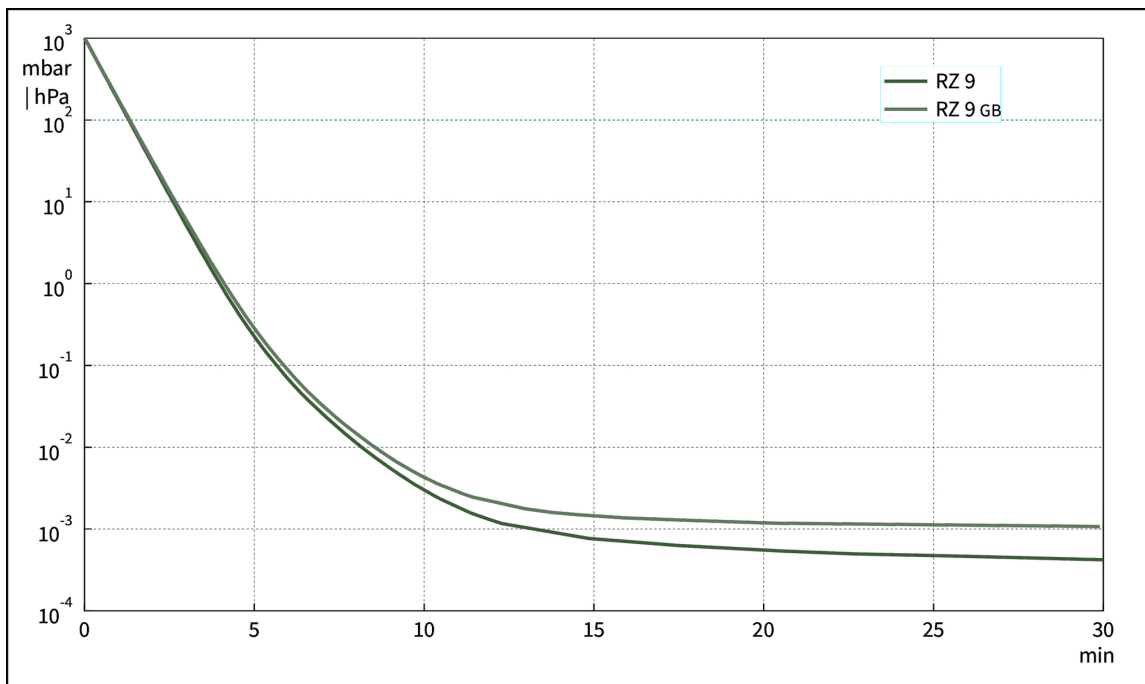

## Dimension sheet

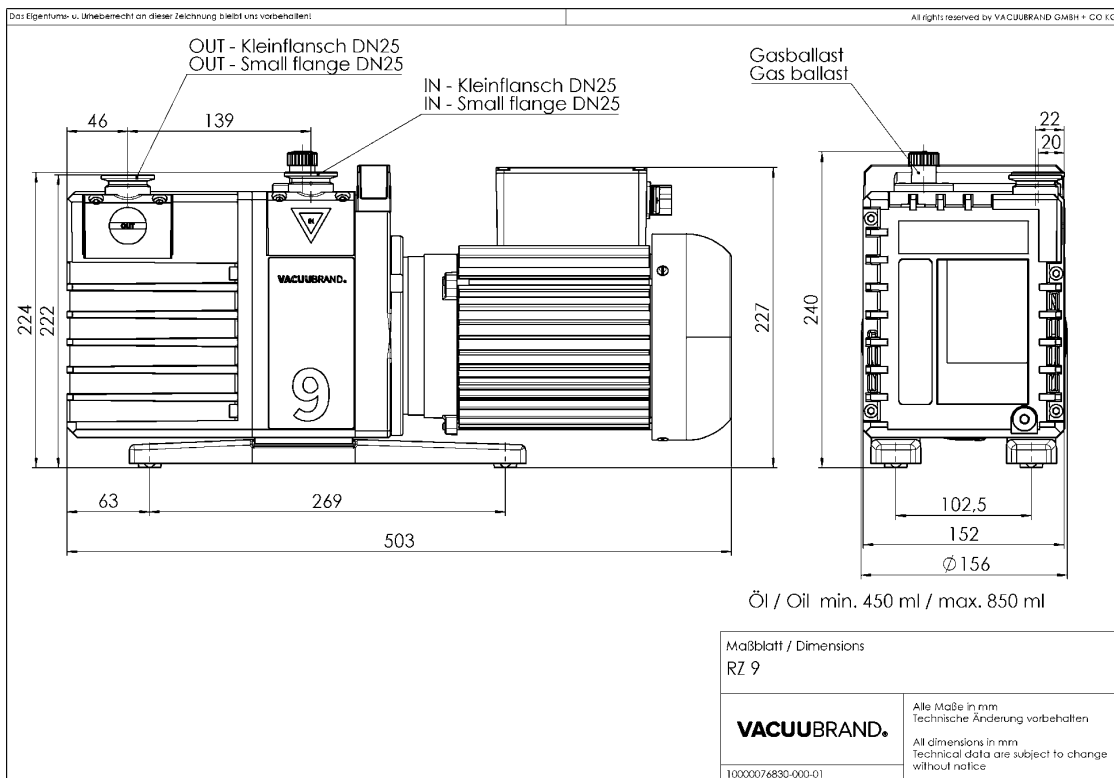
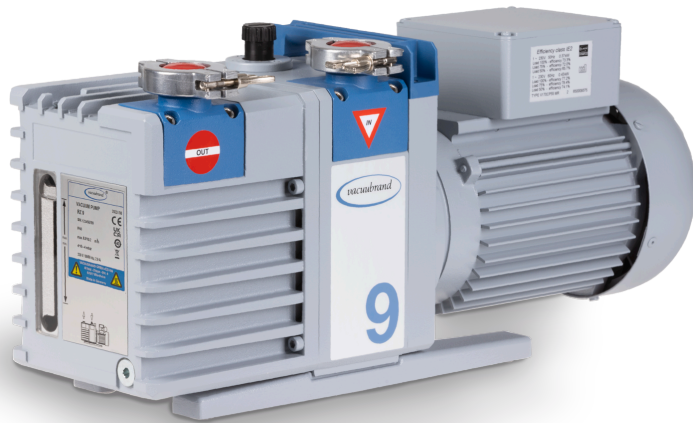

VACUUBRAND GMBH + CO KG  
P.O. Box 1664  
97877 Wertheim  
T +49 9342 808 5550  
F +49 9342 808 5555

info@vacuubrand.com  
www.vacuubrand.com

**VACUUBRAND®**

VACUUBRAND is part of the Brand group, a manufacturer of high-quality and innovative laboratory equipment and vacuum technology with a global team of approx. 1,000 employees.

With highly motivated and qualified employees, we manufacture the world's most comprehensive product family for vacuum generation, measurement and control for the rough and fine vacuum range in the laboratory.

**All with one goal:**

Enabling our customers to run reliable, safe and efficient processes. This is why we commit ourselves to continuous innovation, first-class performance, and outstanding quality.

Engineering excellence is central to our ability to deliver products and solutions renowned for their quality, durability, and reliability. Innovative technology, high quality materials and extensive testing deliver unmatched performance - engineered and manufactured in Germany.

Together with you, our experts will find the best solution for your application and provide you with first-class service along the way.

BRAND (Shanghai) Trading Co., Ltd.  
Shanghai, China

T +86 21 6422 2318  
info@brand.com.cn  
china.brand.com.cn

BRAND Scientific Equipment Pvt. Ltd.  
Mumbai, India

T +91 22 42957790  
customersupport@brand.co.in  
www.brand.co.in

BRANDTECH® Scientific, Inc.  
Essex, CT. United States of America

T +1 860 767 2562  
info@brandtech.com  
www.brandtech.com